

HL62BP/5

6 l/s
DN160

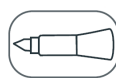

0317.1E

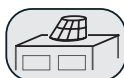

062B.2E



062B.3E



170

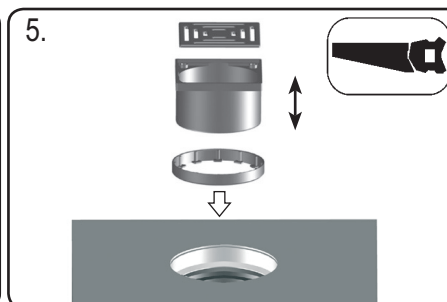
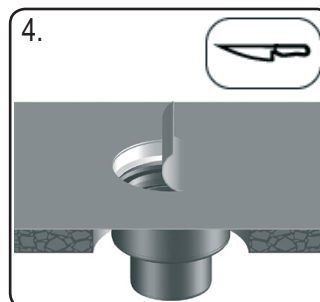
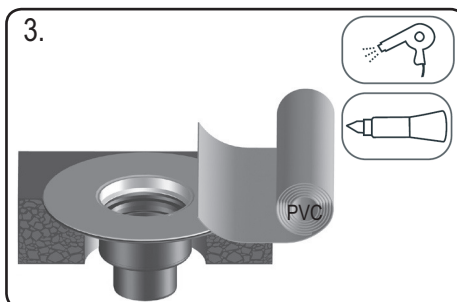
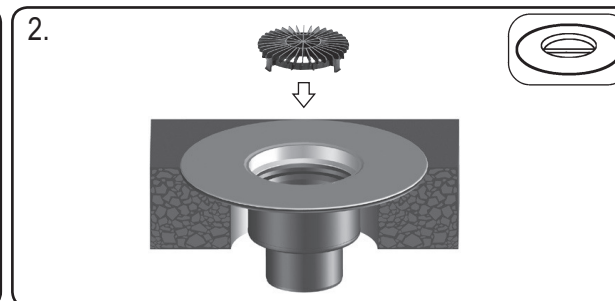
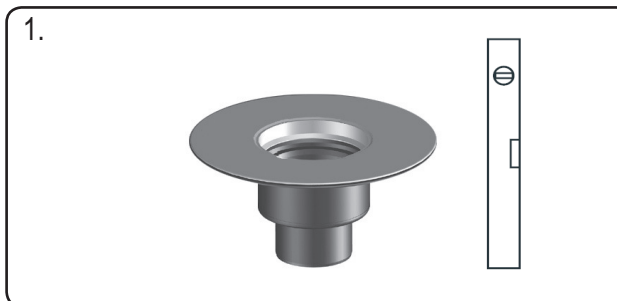

D Flachdach-Ablauf
I Scarico per tetti piani
GB Flat-roof drain

TR Düz çatı süzgeci
CZ/SK Střešní vtok
EX-YU slivnik za ravni krov

H Lapostető lefolyó
PL Wpust dachu płaskiego
SLO Odtok ravne strehe

RO Scurgere de pe terase
PYC Воронка для плоской кровли
BUL воронка за плосък покрив

01.06.2010