

HL510N-3124

< 0,5 l/sec
DN 40/50

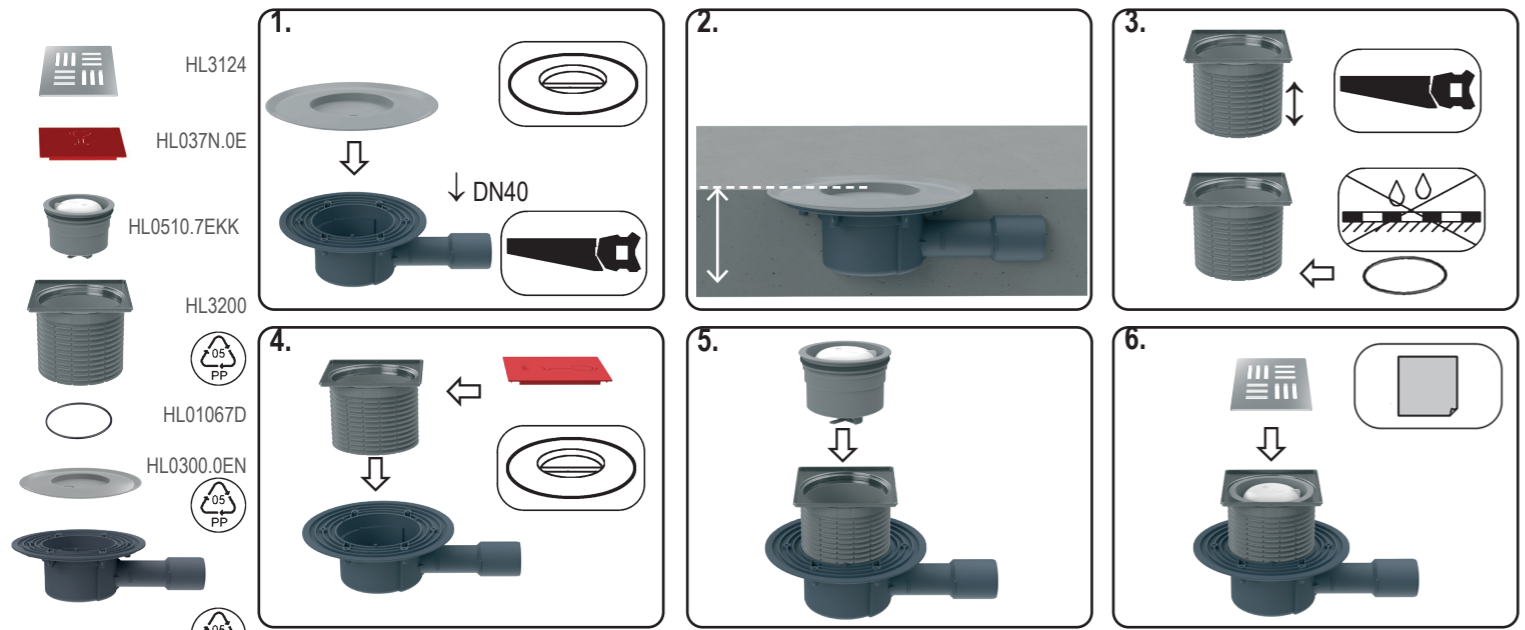
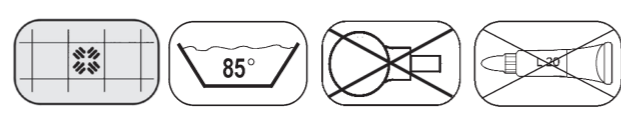

D BODENABLAUF
IT SCARICO A PAVIMENTO
GB FLOOR DRAIN
TR YER SÜZGEÇİ
CZ/SK PODLAHOVÁ VPUST
HR PODNI ODVOD
HU PADLÓLEFOLYÓ
PL WPUST PODLOGOWY
SI TALNI ODTOK
RO SIFON DE PARDOSEALĂ
RU ТРАП
BG ПОДОВ СИФОН

27.02.2024

HL510N-3124

< 0,5 l/sec
DN 40/50

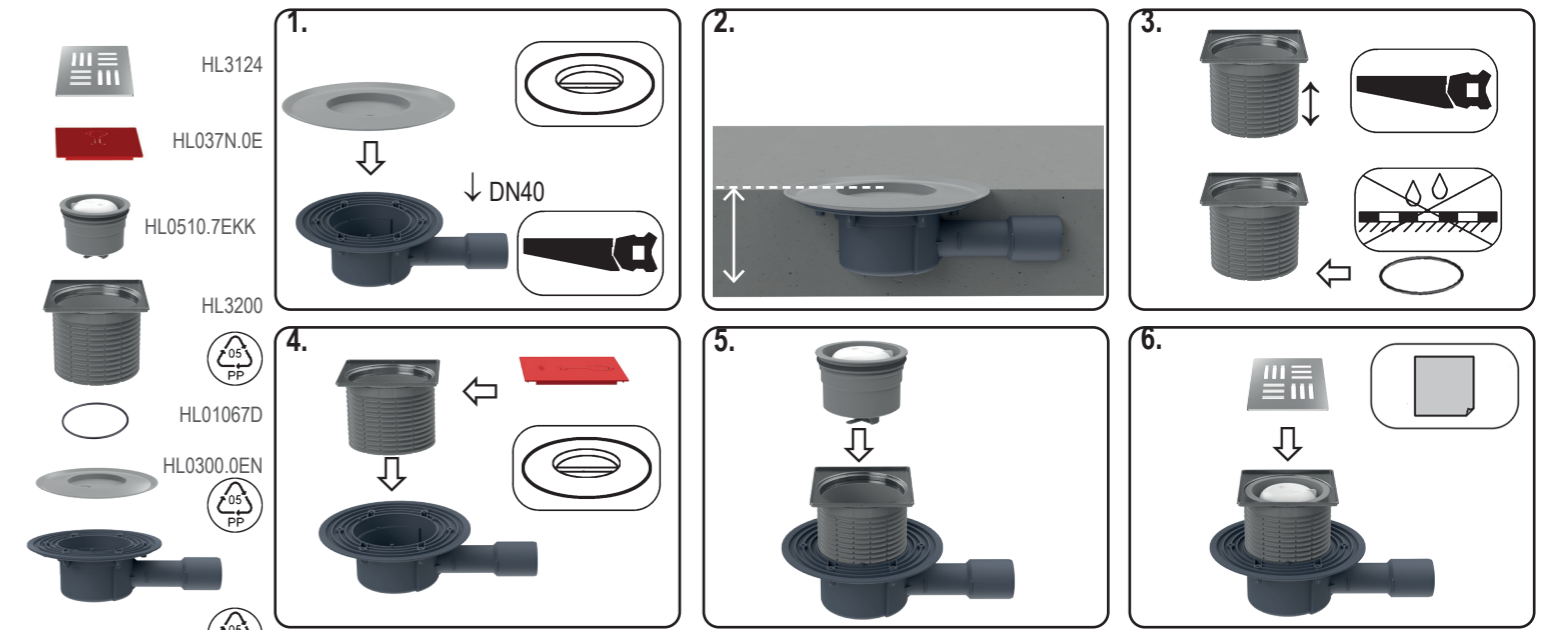
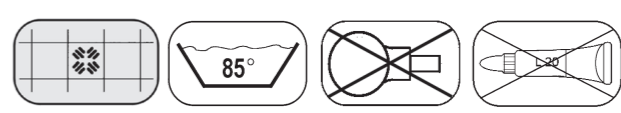

D BODENABLAUF
IT SCARICO A PAVIMENTO
GB FLOOR DRAIN
TR YER SÜZGEÇİ
CZ/SK PODLAHOVÁ VPUST
HR PODNI ODVOD
HU PADLÓLEFOLYÓ
PL WPUST PODLOGOWY
SI TALNI ODTOK
RO SIFON DE PARDOSEALĂ
RU ТРАП
BG ПОДОВ СИФОН

27.02.2024

HL510N-3124

< 0,5 l/sec
DN 40/50

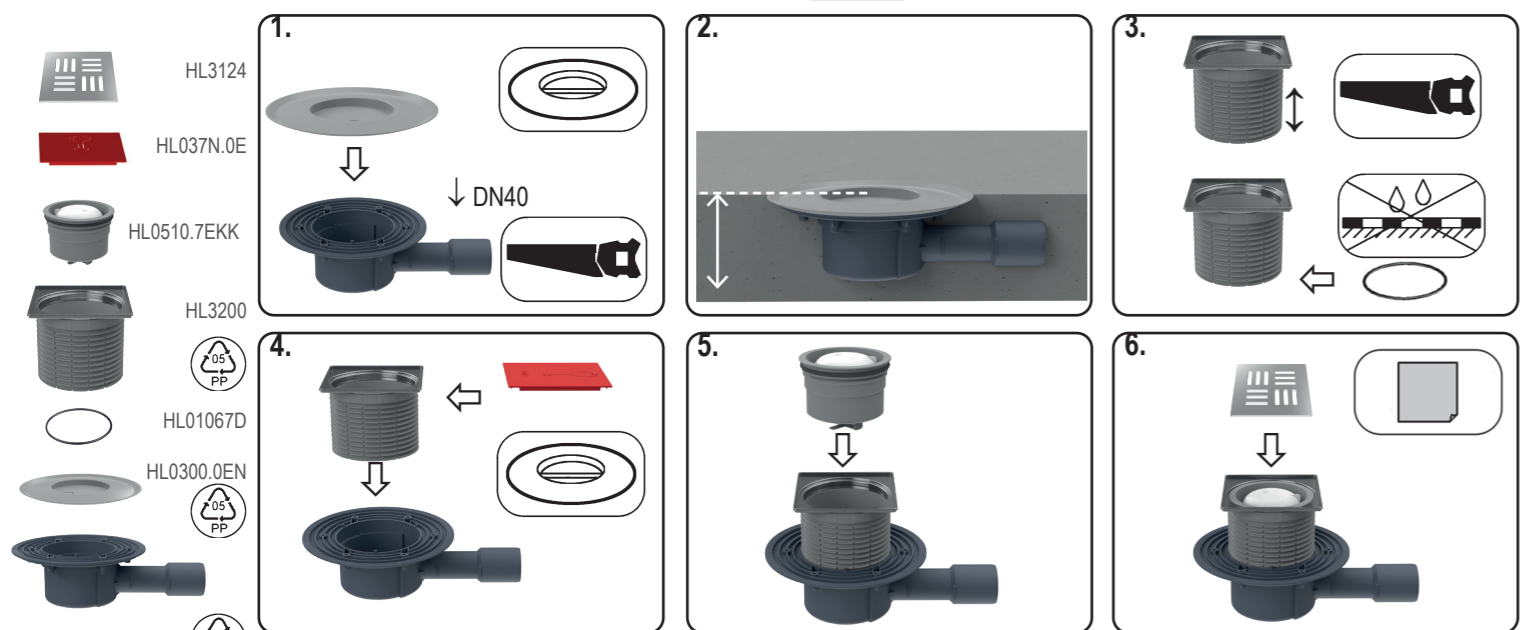

D BODENABLAUF
IT SCARICO A PAVIMENTO
GB FLOOR DRAIN
TR YER SÜZGEÇİ
CZ/SK PODLAHOVÁ VPUST
HR PODNI ODVOD
HU PADLÓLEFOLYÓ
PL WPUST PODLOGOWY
SI TALNI ODTOK
RO SIFON DE PARDOSEALĂ
RU ТРАП
BG ПОДОВ СИФОН

27.02.2024

HL510N-3124

< 0,5 l/sec
DN 40/50

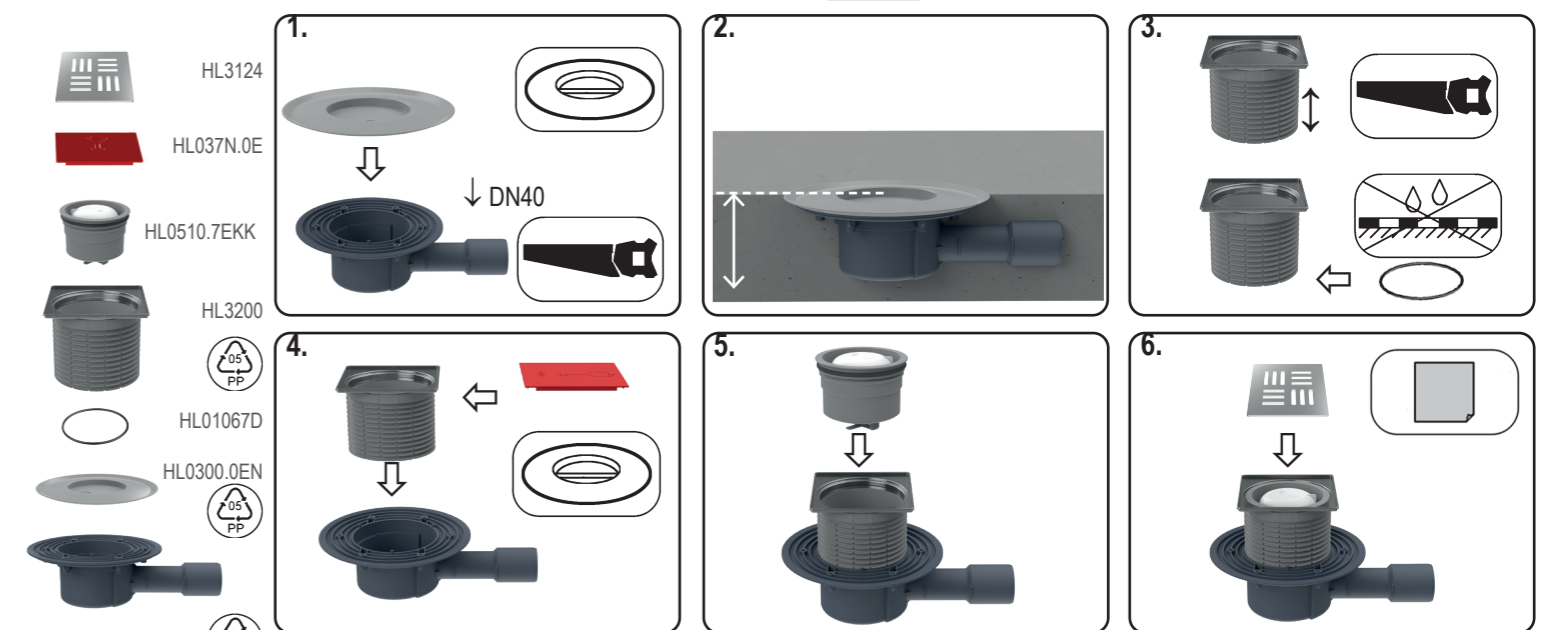

D BODENABLAUF
IT SCARICO A PAVIMENTO
GB FLOOR DRAIN
TR YER SÜZGEÇİ
CZ/SK PODLAHOVÁ VPUST
HR PODNI ODVOD
HU PADLÓLEFOLYÓ
PL WPUST PODLOGOWY
SI TALNI ODTOK
RO SIFON DE PARDOSEALĂ
RU ТРАП
BG ПОДОВ СИФОН

27.02.2024